

Instruction Manual

BEFORE USING THE RECTIFIER CHARGER UNIT

Be sure to read this instruction manual thoroughly before using this product. Pay attention to all cautions and warnings before using this product. Incorrect usage could lead to an electrical shock, damage to the unit or a fire hazard.

DANGER

Never use this product in locations where flammable gas or ignitable substances are present. There are risks of igniting these substances and exploding by an arcing.

WARNING

- Do not touch this product or its internal components while circuit in operation, or shortly after shutdown. There may be high voltage or high temperature present and you may receive an electric shock or burn.
- While this product is operating, keep your hands and face away from it as you may be injured by an unexpected situation.
- Do not make unauthorized changes to this product, otherwise you may receive an electric shock and void your warranty.
- Do not drop or insert anything into this product. It might cause a failure, fire and electric shock.
- Do not use this product under unusual condition such as emission of smoke or abnormal smell and sound etc. It might lead to fire and electric shock. In such cases, please contact us. Do not attempt repair by yourself, as it is dangerous for the user.
- Do not operate these products in the presence of condensation. It might lead fire and electric shock.

CAUTION

- This power supply is designed and manufactured for use within an end product such that it is accessible to SERVICE ENGINEERS only.
- Confirm connections to input/output terminals are correct as indicated in the instruction manual before switching on.
- Input voltage, Output current, Output power, ambient temperature and ambient humidity should be kept within specifications, otherwise the product will be damaged.
- Do not operate and store this product in an environment where condensation might occur. In such case, waterproof treatment is necessary.
- Do not use this product in environment with a strong electromagnetic field, corrosive gas or conductive substances.
- For applications, which require very high reliability (Nuclear related equipment, medical equipment, traffic control equipment, etc.), it is necessary to provide a fail-safe mechanism in the end equipment.
- Do not inject abnormal voltages into the output or signal of this product. The injection of reverse voltage or over voltage exceeding nominal output voltage into the output or signal terminals might cause damage to internal components.
- Never operate the product under over current or short-circuit conditions, or outside its specified Input Voltage Range. Insulation failure, smoking, burning or other damage may occur.
- This product contains a printed circuit board utilizing surface mounted devices. PCB stress such as bending, twisting etc. could cause damage. Therefore, please handle with care.
- This power supply has possibility that hazardous voltage may occur in output terminal depending on failure mode.
- The output of the device is considered to be a hazardous energy level (The voltage is 100V or more.) It must not be made accessible to users. Protection must be provided for Service Engineers against indirect contact with the output terminals and/or to prevent tools being dropped across them. While working on this product, the AC Input power must be switched off and the input and output voltage should be zero.
- These models have a built-in fan for air-cooling. Do not block the air intake and exhaust as this might lead to fire.
- The information in this document is subject to change without prior notice. Please refer to the latest version of the data sheet, etc., for the most up-to date specifications of the product.

1. GENERAL INTRODUCTION

1.1 SYSTEM DESCRIPTION

AETES 1PH Series Rectifier / Battery Charger is a high technology equipment, including all protection and control systems, which is designed and manufactured to convert 1 phase AC voltage to pure and regulated DC voltage. It provides DC power, which is especially important for industrial, telecom and military applications.

When this system is used with a battery group at its output, this equipment charges batteries and acts as a uninterrupted DC power source.

This equipment contains an input isolation transformer and provides full electrical isolation between input supply and DC output.

This uses all advantages of Digital Signal Processor control. It provides advanced user interface, smart diagnostics and advanced communication features.

When used as battery charger, it can perform battery charge in 3 different modes:

- Float charge
- Equalizing charge
- Boost charge

1.2 OPERATION THEORY

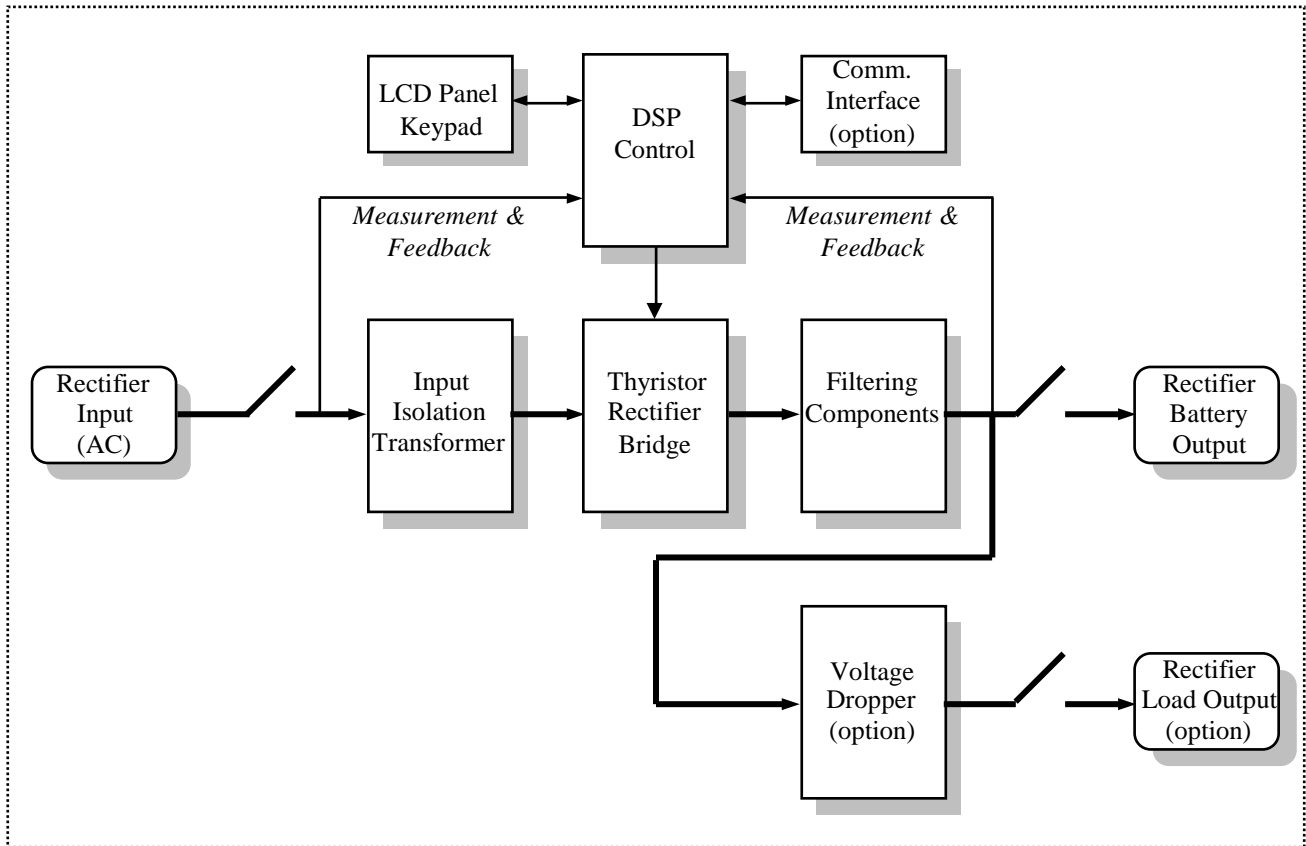

Figure 1.1 AETES Rectifier Block Diagram

1.3 TRANSITION BETWEEN CHARGE MODES

The device can apply 3 different charging voltages. These are Float, Equalize and Boost Charge charge voltages. When in auto charge mode, the device automatically switches between Float and Equalize charge modes.

Float Charge Mode

In this charging mode, the device applies Float charging voltage to the load (battery), limiting the current if necessary. There is no time limit. The float charge charges the battery at buffering value.

Equalize Charge Mode

In this charging mode, the device applies the Equalize charging voltage to the load (battery), making current limit if necessary. There is no time limit. The Equalize charge is a fast charge which is high in the battery charging process.

Boost Charge Mode

In this charging mode, the device applies Boost charging voltage to the load (battery), limiting the current if necessary. This charging mode is also limited in terms of time with the Boost Duration setting value. If this time expires, the device returns to Float Charge and Fast Charge is blocked for the next 1 hour. After 1 hour, the device switches itself to Boost Charge again.

The quick charge is used only for the first commissioning for some special types of batteries.

Automatic Charge Mode

In a rectifier set to operate in automatic charging mode, automatic switching between float and balancing charges is done automatically. These criterias are current value and time. As a current criterion, two threshold values are mentioned: Flotation Current and Equalize Current. As a time criterion, there is only one value called Boost Duration. All three values can be set by the user under the Settings menu. The mechanism works as follows:

1. If the current value drawn from the battery is below the Float current set value, the device switches to Float Charge mode within 30 seconds.
2. If the current value drawn from the battery is above the set value of the Equalizing Current, the device switches to Equalizing Charge mode within 30 seconds. However, this can be done if at least 60 minutes have passed since the last successful Fast Charge
3. If the device has entered Equalize Charge mode for any reason, Equalizing Charge can last as long as the Boost Duration value, after which the device will go into Float Charge mode if the device is still in Equalizing Charge mode and start the 60 minute Fast charge Block period mentioned in the second item. As long as fast charge block is active, the device can not switch to Equalize charge.

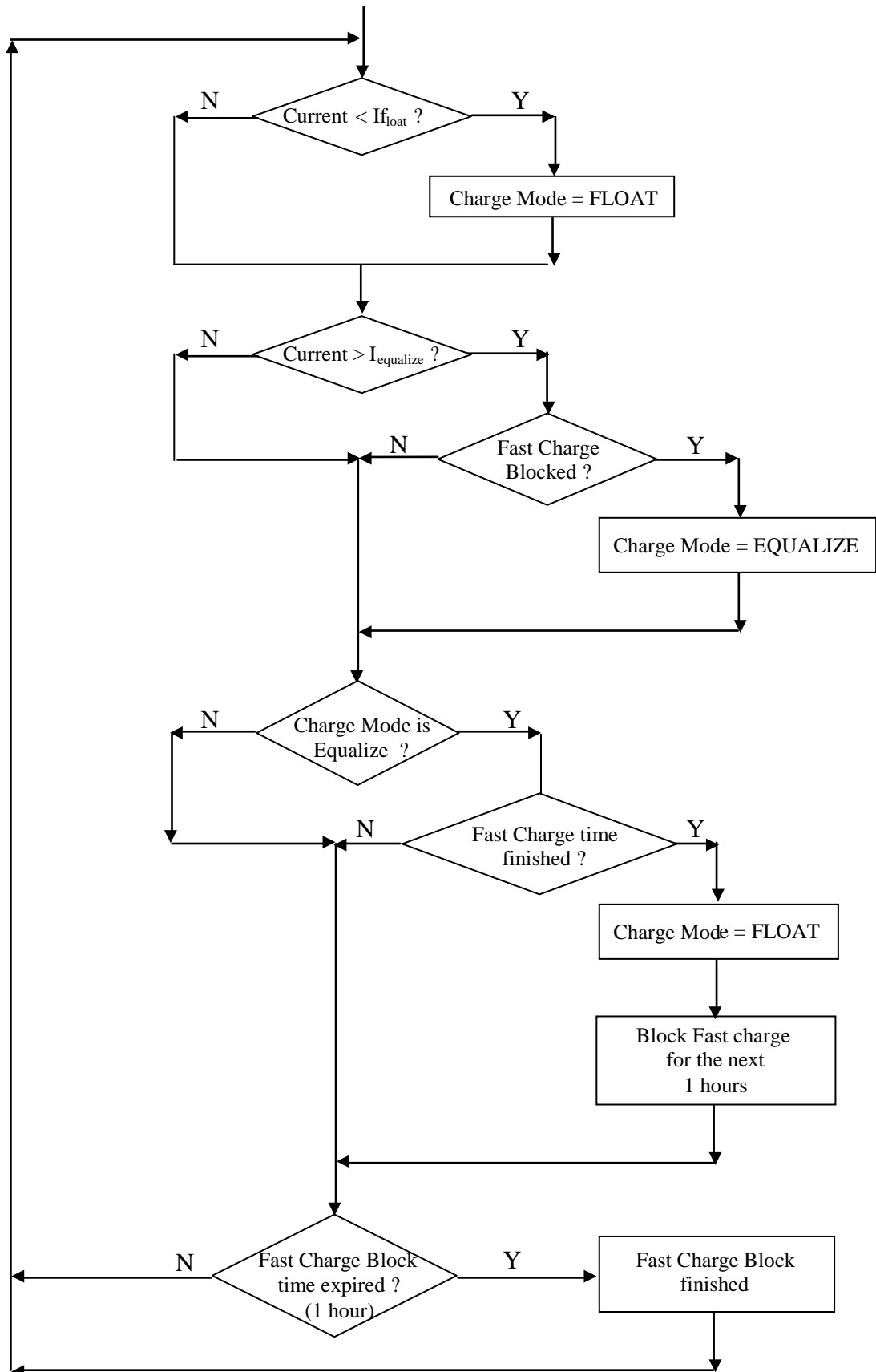

Figure 1.5 AETES Automatic Charge Mode Transition Flowchart

1.4 CURRENT LIMITING

Current limiting is the action that the rectifier reduces its voltage to limit the current. The AETES rectifier has the feature. If the output current exceeds the Current Limit setpoint or battery current exceeds Batt. Current Limit setpoint (both here defined under **Main Menu > Setup**), the output voltage is reduced until the current drops below the setpoint. In this case, a Current Limit message is displayed. This is constant current operation mode. The rectifier do not trip its outputs.

During the battery charge process, an empty battery may force the rectifier to run at current limit mode for a short period. After the battery is enough charged, it will demand for less current and the rectifier will leave the current limit.

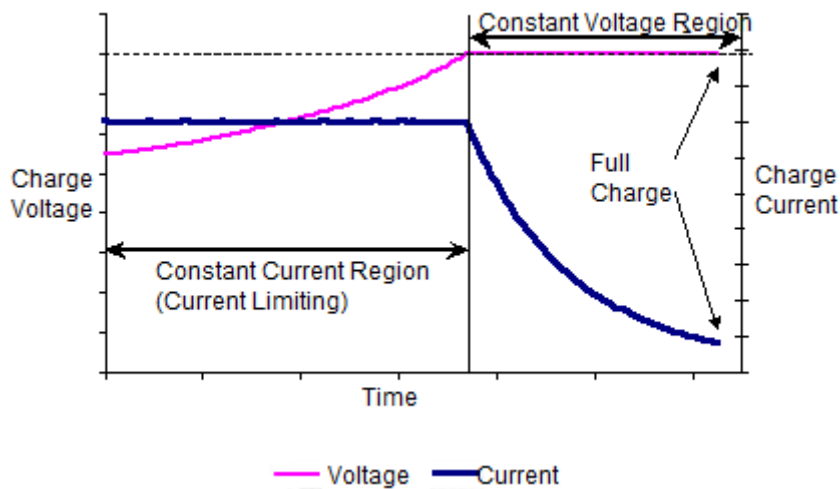

Figure 1.6 Battery Charging with Current Limiting

2. SETUP

2.1 OPENING PACKAGE

When the equipment is delivered to you, first to be examined is a possible damage during transport. Therefore, examine the equipment carefully. For a possible future use, save the packet and wooden pad of the rectifier after unpacking.

2.2 CHOOSING PROPER PLACE

1. For a proper ventilation, minimum distance between the rear of the rectifier and any nearby object should be minimum 20 cm.
2. Choose a place with proper temperature and humidity.
3. Do not choose any place which can cause dust and corrosion.
4. The place chosen should not have direct sunshine and shouldn't be near any heating source.
5. Operating the equipment in proper conditions will increase its lifetime.

2.3 ELECTRICAL CONNECTION

All electrical connections of the rectifier exist on the back of the front door of the enclosure. All required connections to connection panel of rectifier should be made by AETES service personnel or by the approval of AETES service personnel.

Before making the connections all power switches, isolators and circuit breakers must be in OFF position.

CAUTION

Your device may have different connections and terminals, depending on your project and specifications. Please refer to the drawings and terminal labels before proceeding.

Input AC supply should be connected to X1 terminal.

In devices where battery output and load output are separated, battery should be connected to X2 and load should be connected to X3.

In devices where battery output and load output are common, both battery and load should be connected to X2 and load should be connected to X3.

Ground must be connected.

CAUTION

Connect and control ground (PE) connection. Definitely, the equipment shouldn't be operated without ground connection.

3. OPERATION

3.1 TURNING ON THE EQUIPMENT

1. Apply line voltage from the connected distribution panel to the rectifier, when the rectifier input breaker K1 is in OFF position.
2. Switch the input breaker K1 to ON position. Rectifier will be energized and welcome message will be shown on the front panel.
3. With a soft start, the rectifier will start to generate DC output voltage, if automatic startup is set. (See Section 5, Front Panel)
4. If manual startup is set, the rectifier will wait without generating DC. In this case, push ON buttons on the front panel.
5. From the rectifier side of the K2 output breaker, control the DC voltage, with a voltmeter, or from the LCD panel.
6. Switch the K2 output breaker to ON position. Rectifier will feed output loads. If exists, switch the K3 output breaker to ON position, too.
7. Output voltage and output current can be observed via the LCD panel.

3.2 TURNING OFF THE EQUIPMENT

1. Push OFF buttons on the front panel of the rectifier. Rectifier will stop generate DC voltage.
2. Switch input breaker K1 and output / load breakers K2 / K3 to OFF position.

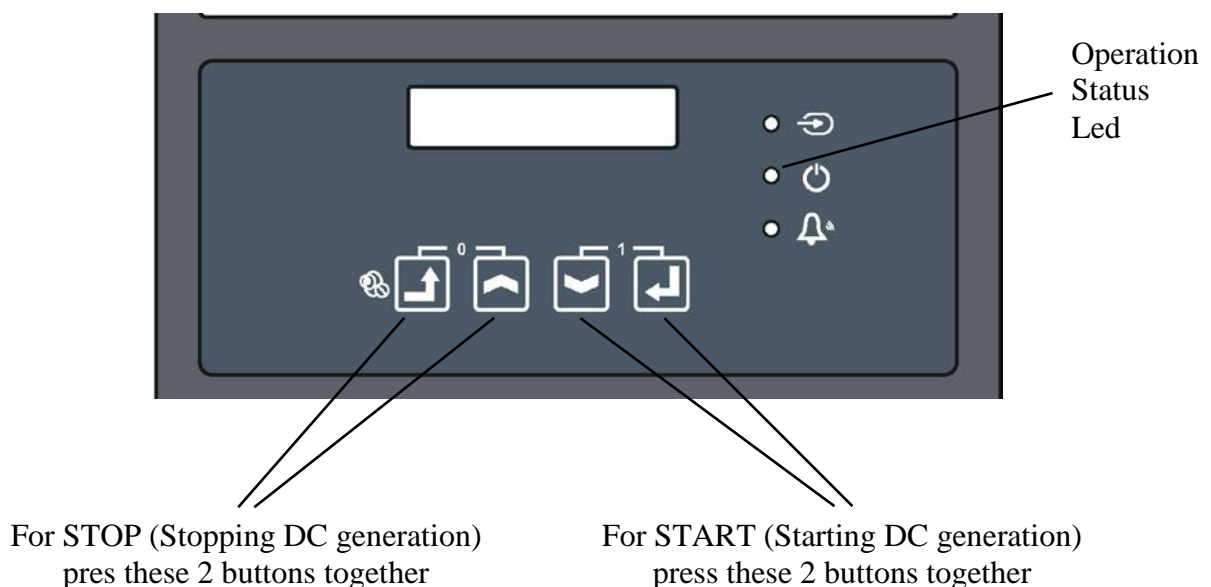

Figure 3.1 Starting and Stopping Rectifier

3.3 AUTOMATIC STARTUP

It can be programmed, whether the rectifier starts its operation itself or not, when the AC input supply is applied. (See Section 5, Front Panel)

A rectifier programmed for automatic startup will automatically start its operation and generate DC, when the AC input supply is applied. This option is especially preferred for far installations, where user intervention is not possible. In this mode, if a trip because of an alarm condition occurs, the rectifier will automatically restart and generate DC, after the alarm condition is disappeared. This status can be observed by the blinking operation led.

A rectifier programmed for manual startup will wait for the user to push ON buttons to start, after the AC input supply is applied.

A device programmed for Automatic Startup resets the DC High alarm, 20 seconds after it has been detected. If the alarm appears again after the restart, this scenario is repeated 4 times. After the 4th attempt, if the time lapse between last two alarm was less than 10 minutes, the rectifier decides that there is a permanent problem and service needed, therefore it stops automatic alarm reset and automatic restart and remain in alarm state.

4. SERVICE AND MAINTENANCE

CAUTION

There are no by the user servicable parts inside the equipment, therefore DO NOT OPEN THE COVER OF THE EQUIPMENT. Because of possible external battery connection and dry contact relay outputs, THERE MAY BE HIGH VOLTAGE INSIDE THE EQUIPMENT , EVEN WHEN THE RECTIFIER IS TURNED OFF. Do not permit unauthorized persons to intervent any failure, otherwise, the warranty will be void and moreover, significant injury may occur.

Under normal operating conditions only preventative maintenance is required. The intervals between maintenance actions will vary according to the level of remote monitoring and the standard of cleanliness of the equipment room.

4.1 PERIODICAL MAINTENANCE

The rectifier equipment is designed for a very minor maintenance requirement. Only fulfil conditions described below.

1. Clear the dust piled up in ventilation holes of the equipment.
2. You may clean the cover of the equipment with a moist cloth.
3. Record all abnormal occurrences in the service log
4. Visually check electrical connections and component for signs of overheating or corrosion.
Rectify as necessary.

4.2 FAILURES

As mentioned before, only authorized personnel may perform maintenance of the equipment. In any abnormal situation, before calling service, check the points described below.

4.3 BEFORE CALLING SERVICE

The most simple failure definition for a car problem is “Car is defective.” But, this will not help to the one who must fix the problem, especially when he is not beside the car. There can be several reasons :

- No fuel
Blown gear
- Bad battery
- No start key
No engine
- ...

Therefore, the information provided to the service personel is very important. The information will help him to better undestand the situation.

Please, before calling the service, save your devices model and serial number and be ready to answer the following questions :

1. Did you read the users manual ?
2. Is this the first start up of the device or it was working properly before ?
3. Is there energy on the panel, which the device is connected ?
4. Which alarms are displayed on the LCD display ?
6. What are are status of the LED indicators ?
7. Did you apply START command ? Is the OPERATION led (middle of 3) on ?
8. Are the boards and front panel energized when you switch the AC input breaker on ?
9. What are the status of breakers ?
10. Is this a problem apearing rearly or is it permanently existing ?
11. What are the load and battery ?
12. Did you experience any anormality in you utiliy in last times ?

5. FRONT PANEL

5.1 STRUCTURE OF FRONT PANEL

The front panel of the Rectifier contains a LCD (Liquid Crystal Display), control buttons and leds. Via LCD, measurements and status / alarm messages are displayed in a format, which can be easily understood. Parts in front panel and their functions are given below.

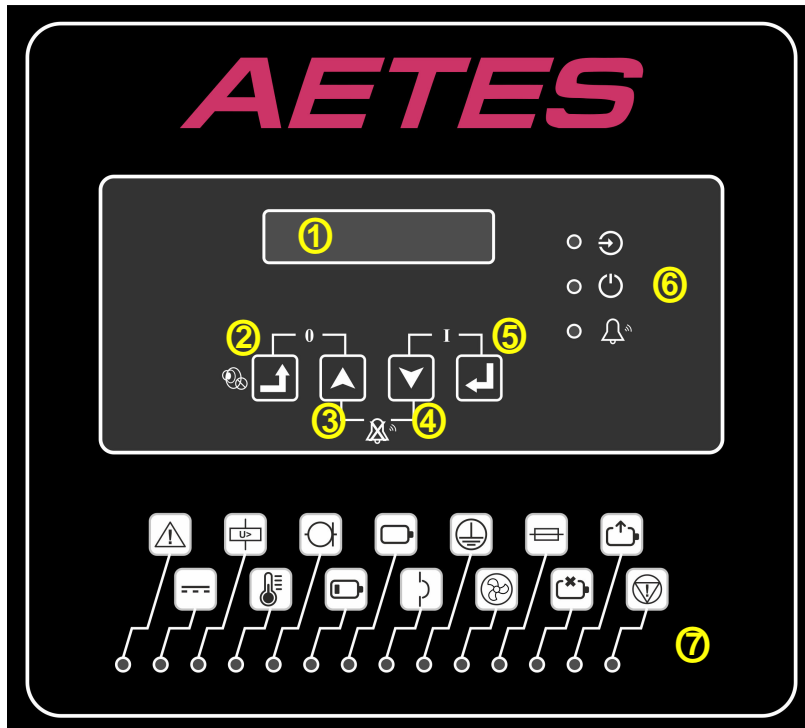

Figure 5.1 Front Panel

1	LCD Display	Measured values, status and alarm messages of the equipment are displayed in this 2x16 character LCD display.
2	Esc Button	This button is used to get back from a submenu or to escape from adjustment without validating.
3	Up Button	In menus, this button is used to see the previous item (up). In adjustments, this button is used to increase the adjusted quantity.
4	Down Button	In menus, this button is used to see the next item (down). In adjustments, this button is used to decrease the adjusted quantity.
5	Enter Button	This button is used to enter a submenu or to validate a setting performed.
6	Led Displays	These leds provide instantaneous information about the status of the equipment. (Input OK / Operation / Common Alarm).
7	Led Indicators	This led panel has individual leds for individual alarms. An energized (lighting) led indicates an actual alarm condition. A blinking led indicates an old, latched alarm condition, that does not exist anymore. Led panel is not supported on all devices.

Led	Color	Status	Description
Input OK	Green	Light ☺	Input AC is OK.
		No Light ☹	Input AC is low or failed.
Operation	Green	Light ☺	The equipment is generating DC.
		Blinking ☹	The equipment has stopped generating DC, because of an alarm condition. Because it is in Automatic Startup mode, it will restart generating DC, after the alarm condition is disappear.
		No Light ☹	The equipment is not generating DC.
Common Alarm	Red	Light ☹	There is an alarm condition.
		No Light ☺	There is no alarm condition.

In LCD display, measured values and status / alarm messages are displayed in separate lines. Via buttons, it is possible to stroll in measurements and submenus.

O	U	T	P	U	T	V	O	L	T	A	G	E		
1	1	0	.	0	V				F	L	O	A	T	🔑

Figure 5.2 LCD Display, Measurements Menu

The single letter located on the bottom right on the LCD display indicates the current charge mode.

Lette	Charge Mode
F	Float Charge
E	Equalize Charge
B	Boost Charge

5.1.1 RESETTING ALARMS















Any active or latched alarm can be cleared by two ways :

- Pressing the most left two button at the same time
- Pressing Enter button on the **Main Menu > Functional > Alarm Reset** item.

5.1.2 MUTING ANY AUDIBLE ALARM TEMPORARY

Any existing alarm can be muted by pressing the ESC button for 10 seconds. The muting condition will remain until all alarms are reset. Once there is no alarm and a new alarm is detected, muting will be deactivated and alarm sound will appear again.

5.1.3 FAULT AND WARNING ICONS

	LINE FAILURE
	DC LOW
	DC HIGH
	OVER TEMPERATURE
	CURRENT LIMIT
	BATTERY LOW
	BATTERY TOO LOW
	BATTERY CIRCUIT BREAKER OPEN
	GROUND FAULT
	FAN FAILURE
	FUSE FAILURE / B.T. FAILURE
	CHARGE FAILURE
	LOAD ON BATTERY
	EMERGENCY STOP

5.1.3 MUTING ANY AUDIBLE ALARM PERMANENTLY

If no audible alarm is requested, JP1 jumper on the LCD display board should be removed.

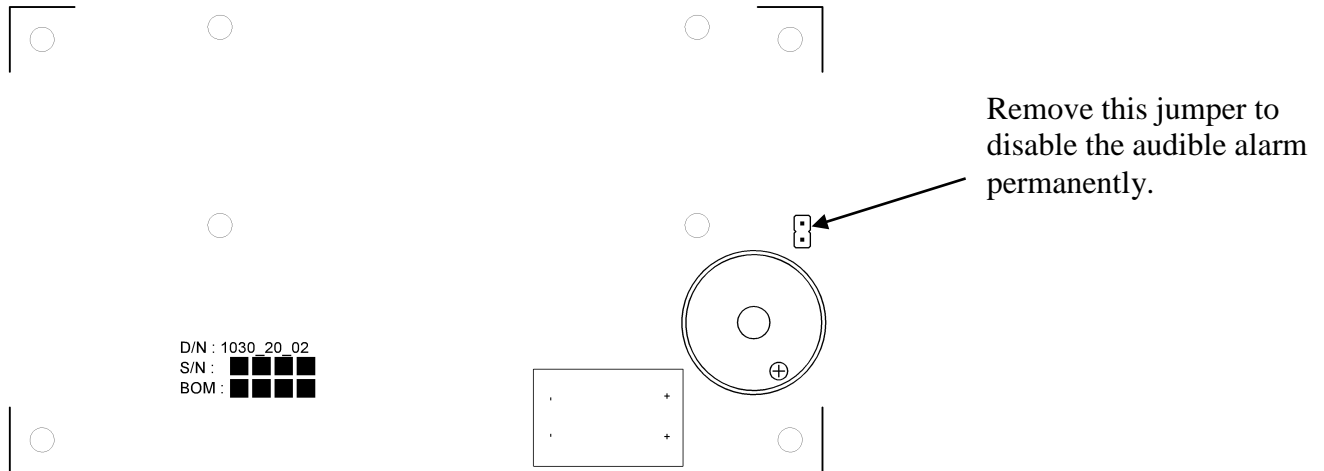

Figure 5.3 Rectifier Front Panel Audible Alarm Cancellation

NOT

Removing JP1 jumper can be performed only by a qualified and trained technical personnel. All circuit breaker of the rectifier should be switch to 0 position and all boards power on lights should be observed as OFF, before performing this operation.

5.1.4 DISABLING PASSWORD PROTECTION

There is a password protection to avoid any unauthorised access to any parameters or adjustment. All parameters can be monitored, but can not modified, until the correct password is entered. A KEY symbol on the right bottom of the LCD display indicates the status of the password protection. The protection is active as long as the key sign is there.

To disable the password protection, correct passord should be entered to **Main Menu > Functional > Password**. Any parameter modification can be done afterwards.

Password protection is automaticly reactivated, if no key is pressed for 5 minutes.

NOTE

Default password is 0000.

NOTE

For service purposes, there is a backdoor access gained by pressing some buttons in a special sequence.

5.1.5 PROGRAMMING RELAY DRY CONTACT OUTPUTS

This procedur explains how to program the drop of the 4 relays dry contact outputs provided by the OPTION-01.

Apply these steps :

- Proceed with Section 5.1.4 and disable password protection.
- Natigate to **Main Menu > Functional > Alarm Relays** and press Enter.
- Select the alarm you want to attact to one or nore relays, press Enter.
- Select the relay or relay you want to attact, press Enter.

In the example below, Breaker Open alarm is attacted to K2 relay.

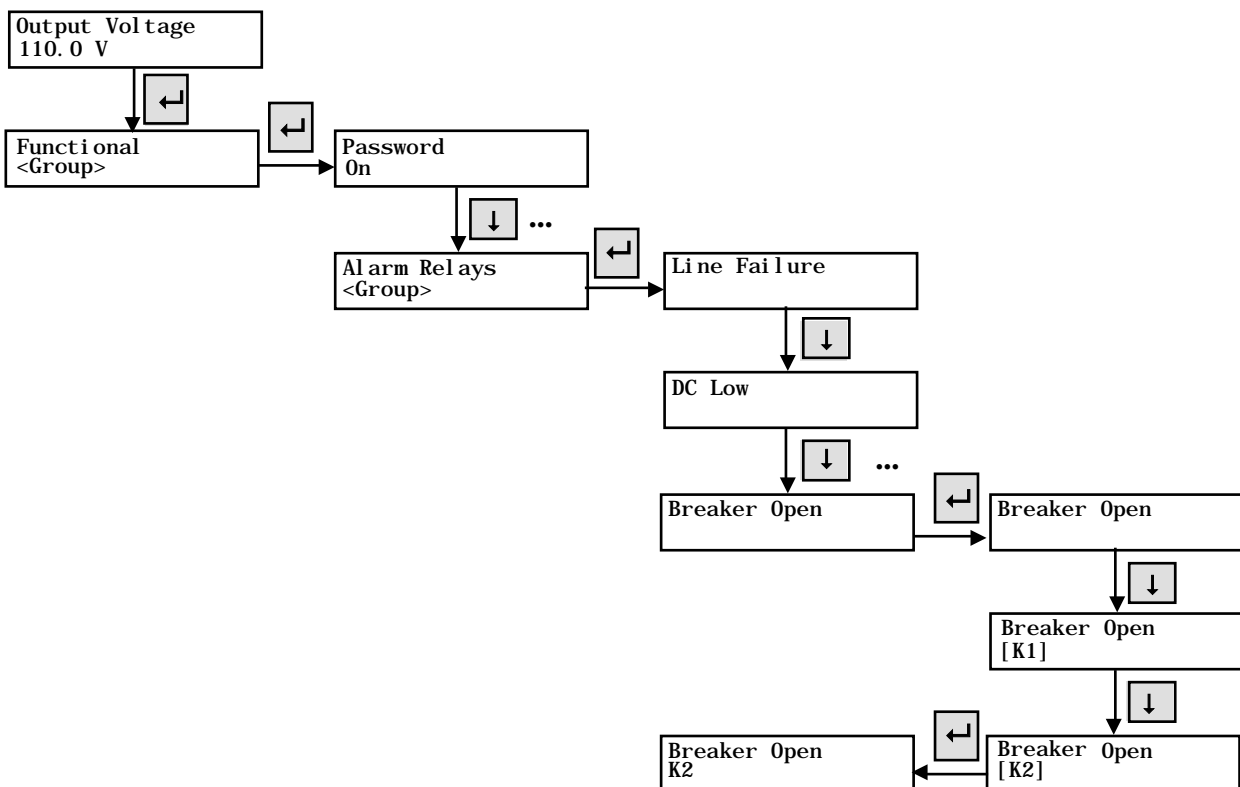

The programming of extra relays up to 12 pieces provided by the OPT-10 can be done under the following submenus.

Main Menu > Functional > Expansion Port > Alarm Relays #2

Main Menu > Functional > Expansion Port > Alarm Relays #3

Main Menu > Functional > Expansion Port > Alarm Relays #4

5.2 MEASUREMENTS MENU

LCD display waits in MEASUREMENTS MENU, after the rectifier has started its operation. UP and DOWN buttons can be used to move ahead this menu. Some measured values of the rectifier are displayed on the LCD display.

Item			Description
1	Output Voltage	[V]	DC output voltage value
2	Output Current	[A]	DC output current value
3	Line Voltage L1	[V]	Input L1 phase AC voltage value (True RMS)
4	Line Voltage L2	[V]	Input L2 phase AC voltage value (True RMS)
5	Line Voltage L3	[V]	Input L3 phase AC voltage value (True RMS)
6	Line Current L1	[A]	Input L1 phase AC current value (True RMS) (Option - 09)
7	Line Current L2	[A]	Input L2 phase AC current value (True RMS) (Option 09)
8	Line Current L3	[A]	Input L3 phase AC current value (True RMS) (Option 09)
9	Battery Voltage	[V]	Battery DC voltage value (Option 03)
10	Battery Current	[A]	Battery DC current value (Option 03)
11	Temperature	[°C]	Temperature value (Battery ambient) (Option 06)
12	Charge Mode	[]	Actual charging mode (Float, Equalize, Boost)
13	Date & Time	[]	Actual date & time
14	Line Frequency	[Hz]	Input AC frequency
15	Input Power	[kVA]	Input AC apparent power(s) (Option 09)
16	Input Power Factor	[-]	Input AC power factor(s) (Option - 09)
17	High Charge Left	[min]	High Rate charge duration left
18	High Charge Block	[min]	High Rate charge block duration left

5.3 ALARM MESSAGES

Alarm and warning messages are displayed timely on the LCD display. Audible alarm is also provided at the mean time. Possible alarm and warning messages are listed below.

Message	Meaning of the message	Action
LINE FAILURE	Indicates that the rectifier AC input voltage is low or failed.	Output trip
DC LOW	Indicates that the rectifier output voltage is lower than the adjustable DC LOW value. System continues to operate.	Alarm only
DC HIGH	Indicates that the rectifier output voltage is higher than the adjustable DC HIGH value. In this case, the equipment will stop generating DC to prevent any damage to batteries or load.	Output trip
CURRENT LIMIT	Indicates that the equipment decreases its output voltage to keep the output current in set current limit value. The equipment is in current limiting and in operates at constant current mode.	Alarm only
BATTERY TOO LOW	Indicates that the measured battery voltage is lower than the adjustable BATTERY TOO LOW value. (Option - 03)	Alarm only
BATTERY LOW	Indicates that the measured battery voltage is lower than the adjustable BATTERY LOW value. (Option - 03)	Alarm only
BATTERY HIGH	Indicates that the measured battery voltage is lower than the adjustable BATTERY HIGH value. (Option - 03)	Alarm only
OVER TEMPERATURE	Indicates that the thyristor bridge temperature has exceeded limits. The equipment will stop generating DC.	Output trip
EARTH FAULT	Indicates there is a leakage current from any of the DC outputs to ground. (Option - 02)	Alarm only
MEMORY ERROR	Indicates, that the DSP control unit can not load the saved parameters properly. In this case, the system will return to factory set values. Until this alarm is resetted via the LCD panel, the equipment does not generate DC.	Output trip
FAN FAILURE	Indicates the failure of the cooling fan. (Option - 15)	Alarm only
BREAKER OPEN	Indicates that one of the output or battery circuit breakers are open.	Alarm only
FUSE FAILURE	Indicates that one or more of the semiconductor rapid fuses has blown. (Option - 14)	Output trip
DOOR OPEN	Indicates that the enclouse door is opened. Used to inform the remote site, in case there is maintenance on the rectifier. (Option)	Alarm only
HARDWARE BLOCK	In devices equipped with an external I/O switch, this message indicates that the rectifier is blocked by taking the switch position to 0. This will prevent the rectifier generating DC output.	Output trip
PROBE FAILURE	In devices performing battery temperature compansation, this message indicates that there is a failure in the temperature sense probe. (Option - 06)	Alarm only

EMERGENCY STOP	Indicates that an emergency stop is activated, by opening contacts connected to alarm & comm. Board X14.	Output trip
PARALLEL FAULT	This message indicates any communication failure between devices connected in paralel. There may be a paralleling hardware or cabling failure. ^(Option 13)	Alarm only
TEMPERATURE PRE. ALARM	In some specifications, it may asked for a TEMPERATURE PRE ALARM. A rectifier displaying this message do not power off its output, but derates its output current periodically the the half of the current in the previous period, so limiting its power output and prevents over heating. But, if this alarm persists for a predefined period, the rectifier powers off its output and the alarm message changes to OVER TEMPERATURE.	Alarm only
12 PULSE FAILURE	Indicated that the 12 pulse controller has detected an error. In this case, the rectifier will limit its current to the half of the nominal to not to overload the 6 pulse bridge. ^(Option 12)	12 pulse rectifier trip
BATTERY TEST FAILED	Indicates that the last battery test is failed. This message remains on the LCD until it is resetted manually by the user. No new test is allowed as long as this alarm exists.	Alarm only
BAD PHASE SEQUENCE	In 12 pulse devices, this message indicates that the input phase sequence is wrong. Replacing 2 of input wires will solve this problem.	Output trip

5.4 CONTROL AND SETTINGS MENUS

Control and Settings Menus can be reached by a push to Enter button, when the screen is in Measurements Menu.

The structure and hierarchy of these menus are given below.

Functional

Password

This item is the password required to modify other adjustable parameters.
The equipment is shipped with default password 0000.

New Password

After the correct password is entered, the password can be modified using this item.

Control Source

Start Mode

This setting defines whether the rectifier will start generating DC voltage itself or after an user intervention, when it is energized.

Language

Defines the language selection for front panel. Device supports up to 5 languages. Default language after factory test is English.

Serial Link (Option 01)

This setting is used to select, which application will occupy the serial link of the rectifier. FreeMaster communication for factory settings or Modbus communication for user purposes can be chosen.

Modbus (Option - 01)

This submenu contains items to setup the Modbus communication.
Only RTU mode is supported.

Baud Rate

Slave No

Parity

Permission

Alarm Relays (Option 01)

This menu block is used to set up which relay or relays will be released in which alarm condition. (Only for devices having Opt 01 option)

Alarm Reset

Led Test

Relay Test

Operation Mode (Option -13)

Factory Settings

Date & Time

Expansion Port (Option -10 and / or Option -11)

Alarm Relays #2 (Option 10)

Alarm Relays #3 (Option - 10)

Alarm Relays #4 (Option 10)

Transducer #0-3 (Option 11)

Transducer #4-7 (Option - 11)

Battery Test

Setup

This menu mainly contain items about electrical settings. (Charge voltages, alarm voltages, charge mode, ...etc.)

Charge Mode

Float Voltage

Equalizing Voltage

Boost Voltage

Float Current

Equalize Current

DC Low

DC High

Battery High (Option - 03)

Battery Low (Option 03)

Battery Too Low (Option 03)

DC Hyst

Current Limit

Battery Current Limit (Option 03)

Boost Duration

Temperature Compansation (Option - 06)

Test Voltage

Test Duration

Log Records

View Logs

Clear Logs

About

Items in this submenu shows software versions and nominal values of the device.

DSP Version

Shows the DSP software version placed on the control board of the device.

uC Version

Shows the microcontroller software version placed on the control board of the device.

V Nominal (V)

Shows the nominal voltage (nameplate value) of the device.

I Nominal (A)

Shows the nominal current (nameplate value) of the device.

V Nom Input (V)

Shows the the nominal input voltage and input voltage type (1 phase or 3 phase) of the rectifier. Moreover, the input phase rotation direction is also displayed as '+' or '-' in three phase devices.

NOTE

For 12 pulse, 3 phase input devices, check that the input phase rotation direction is displayed as '-' inside the **Main Menu > About > V Input (V)**.

NOTE

Default (factory setting) password is 0000.

5.5 MENU TREE

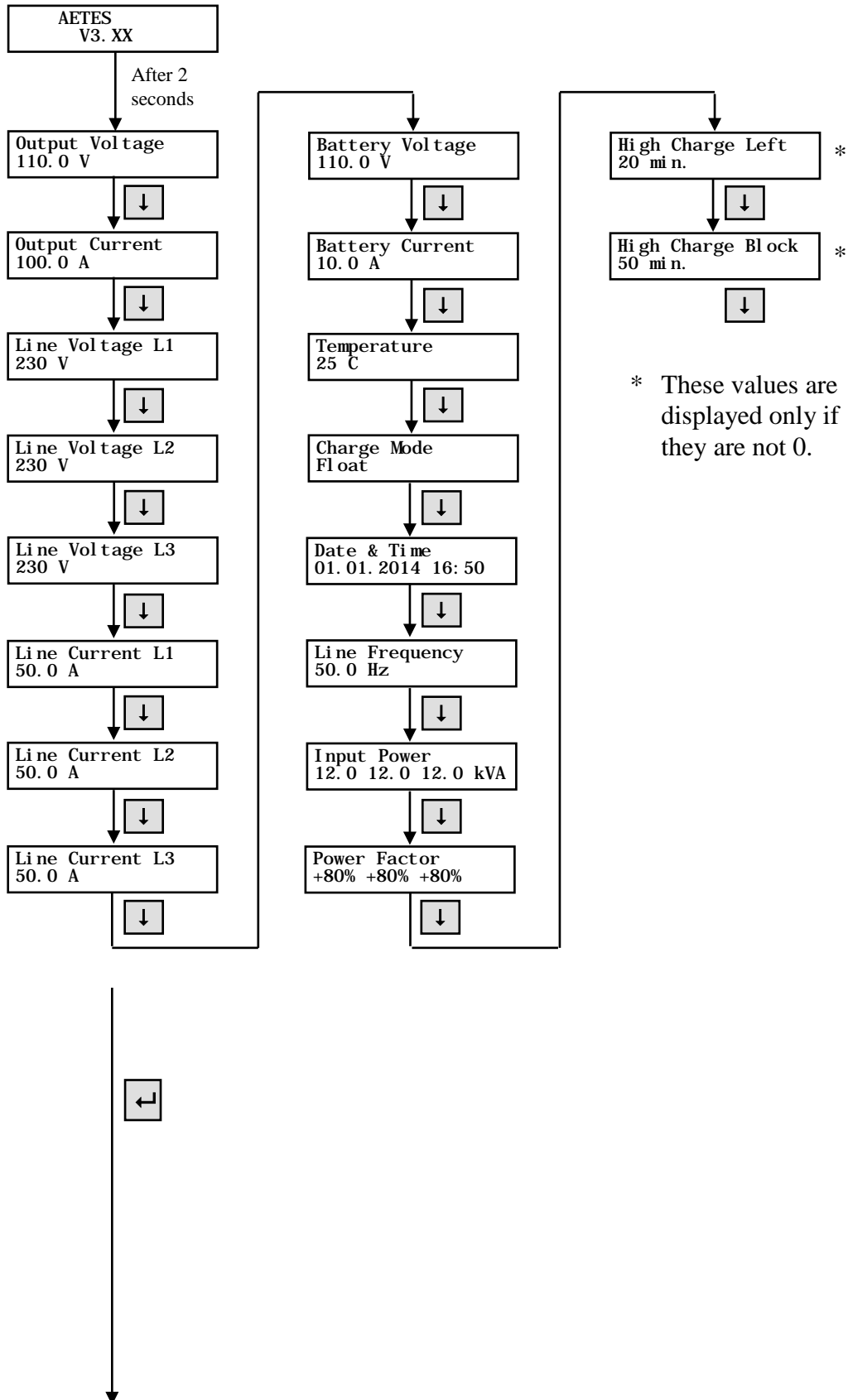

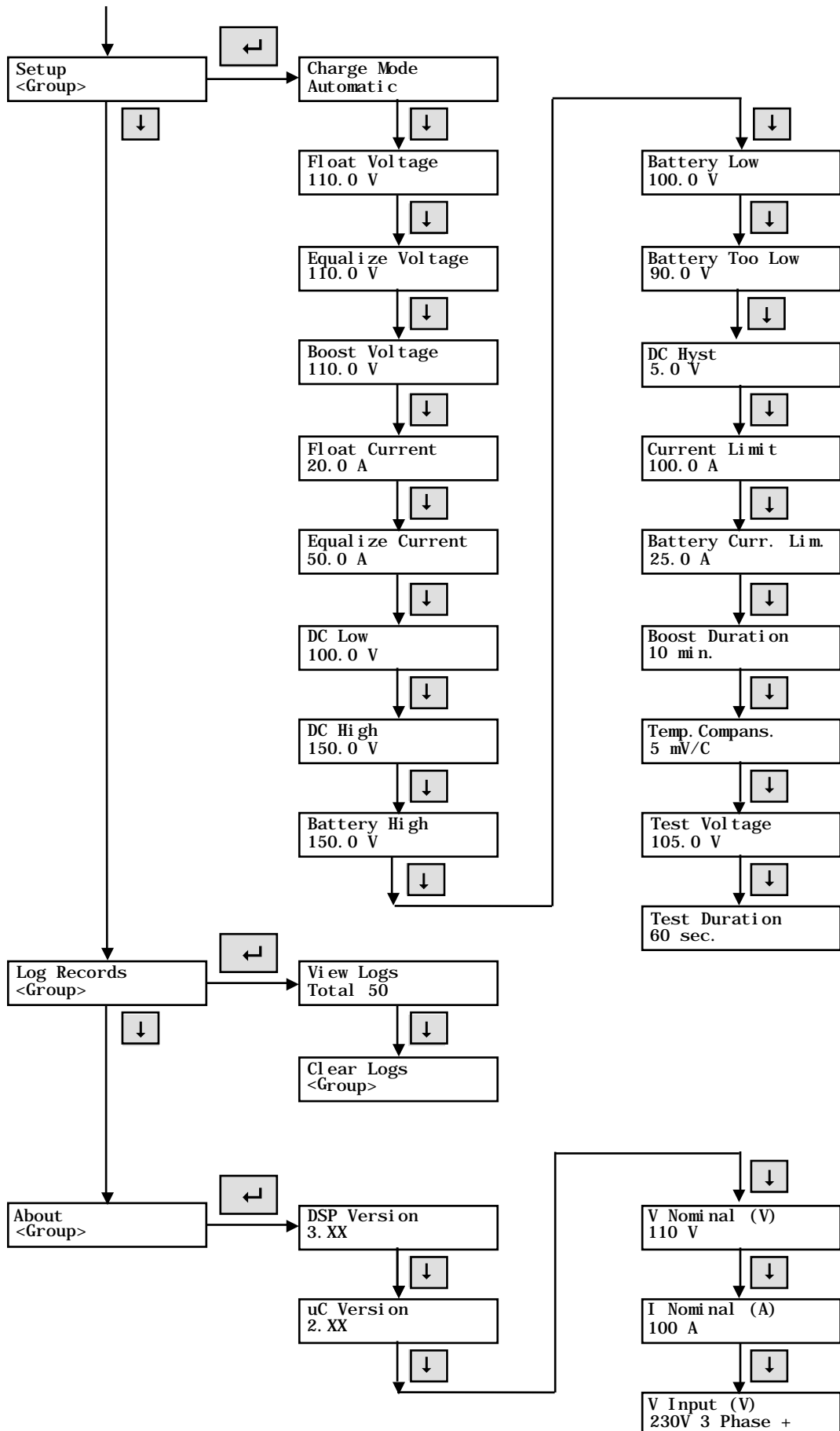

6. OPTIONS

Here is a list of options provided by the AETES Rectifier.

#	OPTION TITLE	OPTION DESCRIPTION
Opt-01	Alarm & Communication Interface Board	Additional Alarm relay contacts and isolated RS232 or RS485 or TCP/IP communication
Opt-02	DC Earth Leakage Monitoring	DC Earth leakage detection and alarm.
Opt-03	HMI /TFT Touch Panel	HMI /TFT Touch Panel and Mimic Diagram
Opt 04	Analog Gauges	Gauges in addition to the LCD panel, especially for high power devices installed in critical applications
Opt-05	Load Voltage Limitation Module / Voltage Dropper	Series diodes are installed to the path from the rectifier output to the load and the voltage the the load is dropper if high rate charge is applied to the battery. This also keeps the load voltage inside some limits.
Opt-06	Battery Charge Voltage Temperature Compansation	This option uses a temperature sensor to sense the battery ambient temperature and allowing the user to derate the charge voltage level of the battery according to the tempeature measured.
Opt-07	Internal Cabinet Lighting	This option adds a LED lamp activated by the openin of the enclosure door.
Opt-08	Internal Cabinet Heater	This option adds thermostat controlled anticondensating heaters and prevents condensation especially in cold and harsh environments.
Opt 09	Input Power Measurement	This option allows to measure and display AC input currents, apparent powers and power factors.
Opt 11	Transducers	This options provides up to 8 transducer outputs with both 0-10V and 4-20mA outputs.

Opt-13	Active Parallel Current Sharing	In addition to the passive paralleling by the output blocking diode, this option provides CAN communication between rectifiers and precise current sharing.
Opt-14	Fast Acting Semiconductor Fuses	In this option, thyristor semiconductors are protected by adding extra fast acting fuses.
Opt-15	Fan Failure Monitoring	This option continuously monitors each cooling fan and displays a FAN FAILURE message if any of them fails.

6.1 ALARM & COMMUNICATION INTERFACE BOARD (Opt-01)

Additional Alarm & Communication Interface Board provides the user RS232 / RS485 or TCP/IP communication and dry contact outputs.

A view of the Alarm & Communication Interface Board is given below.

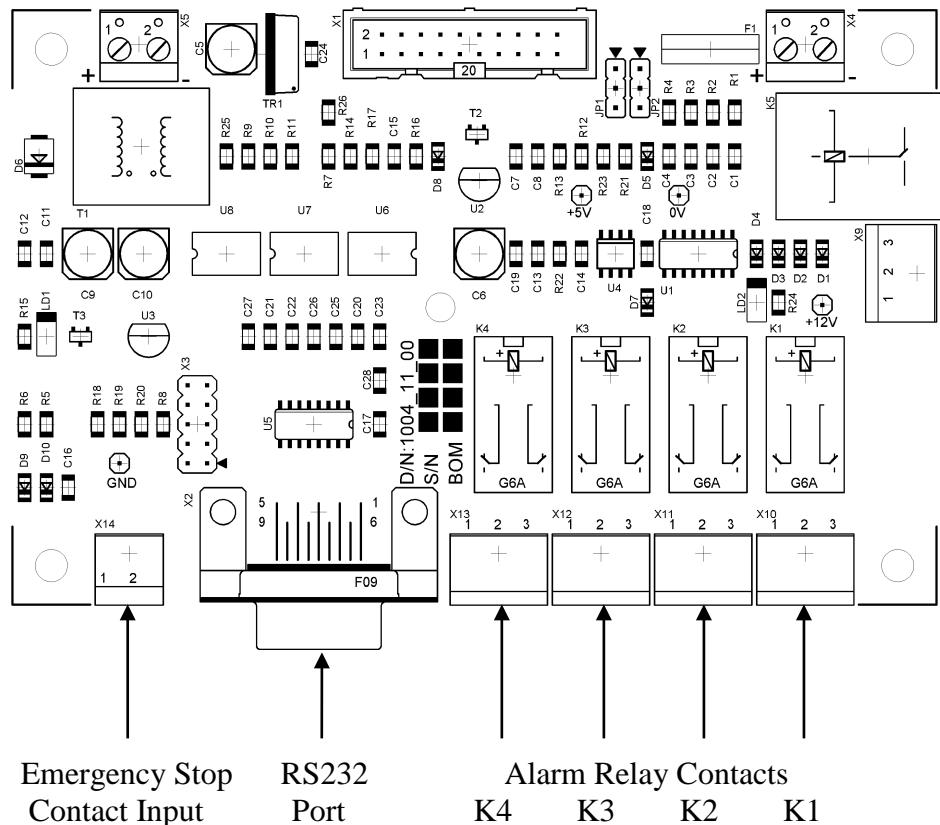

Figure 6.1 Alarm & Communication Interface Board

RS232 port and emergency stop input are isolated from the rest of the rectifier.

Emergency stop input contact can be connected to an external on-door emergency stop button. This contact should be short circuit for normal operation. (Non-emergency state)

6.1.1 Dry Contact Outputs

If more than 4 relay needed, this option can be used. Every additional relay board contains 4 relay outputs. Up to 12 relay outputs (3 relay boards) can be provided. The programming of these additional relay board can be performed inside the **MainMenu > Functional > Expansion Port** submenu.

Dry contact outputs can be programmed by the user via the LCD panel or Modbus communication, depending on the requirement. Although the features of the model is deterministic, the following status can be programmed for the dry contact outputs:

- Line Failure
- DC Low
- DC High
- Current Limit
- Battery Too Low *Option 03
- Battery Low *Option 03
- Battery High *Option -03
- Over Temperature
- Earth Leakage *Option 02
- Memory Error
- Fan Failure *Option -15
- Breaker Open
- Fuse Failure *Option 14
- Door Open *Option
- Hardware Block
- Probe Failure *Option 06
- Float Charge
- Equalize Charge
- Boost Charge
- Emergency Stop
- Parallel Fault *Option -13
- Temperature Pre Alarm *Option
- Test Failed *Option

Dry contacts remain energized, when the alarm condition is not occurred. When the programmed condition occurs (for example, if DC High alarm is detected), dry contact is released and switches to unenergized state. Dry contact outputs are provided to the user directly from plugin sockets placed on the Alarm & Communication Interface Board.

NOTE

Maximum 24Vac or 24Vdc voltage should be applied to dry contacts. Dry contacts are for signaling purposes and can carry maximum 0.5A current.

6.1.2 RS232 /RS485 Communication

This option provides Modbus communication over RS232/RS485 connection, for remote control and monitoring.

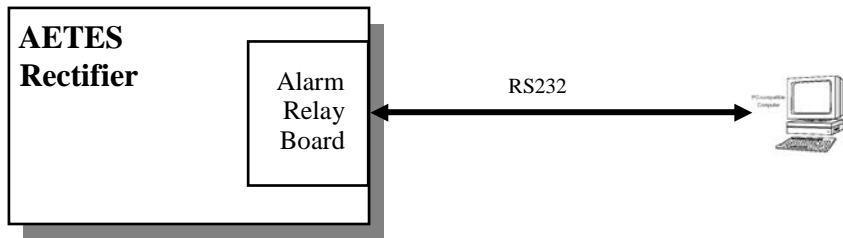

Figure 6.2 Rectifier / PC Connection

For RS232 communication, 9 pin female DSUB connector on the Communication & Alarm Relay Board is used.

Pin connections of the necessary cable for rectifier RS232 connection is given in the table below :

Rectifier side cable (DSUB9 Male)		PC side cable (DSUB9 Female)	
Pin No	Function	Pin No	Function
2	RX	3	TX
3	TX	2	RX
5	GND	5	GND

Depending on the request of the user, it is possible to provide RS485 output, by adding a RS232 / RS485 converter, on the manufacturing.

NOTE

RS232 / RS485 port is isolated from the rest of the rectifier.

NOTE

Modbus address table is given at the end of this document.

Modbus addresses provided in the list are valid according to the most update software version (V3.26) on the date this users manual is prelated. Some new addresses may be added in newer versions, but backward compability is maintained.

Contact four dealer if needed.

6.2 DC EARTH LEAKAGE MONITORING (Option-02)

This option is used to detect a possible leakage current flowing from the DC source to the ground. It is especially preferred in industrial applications and power plants.

When a current from any of the positive or negative poles of the dc power supply flows to the ground, an unbalance occurs in the measurement of the DC bus voltage respect to ground. This unbalance condition is detected by the Earth Leakage Monitoring Board. DC inputs to the Earth Leakage Monitoring Board are fuse protected.

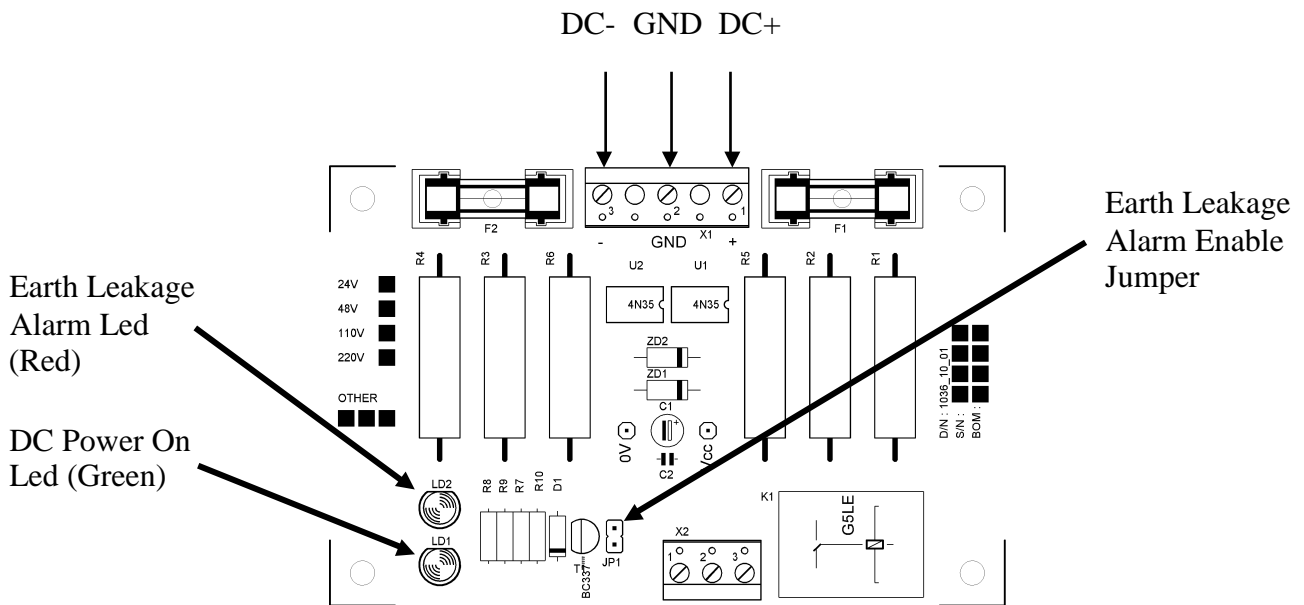

Figure 6.3 Earth Leakage Monitoring Board

NOTE

In some cases, there can be a permanent leakage or solidly earthed DC pole, in plant. It is possible that the user do not want a continuous Earth Fault alarm. In this case, it is enough to remove the jumper JP1 to disable the alarm. This will block the rectifier to display the alarm. The earth leakage board will display any earth leakage alarm by its red led, but the rectifier display not.

6.3 HMI /TFT TOUCH PANEL (Option-03)

HMI /TFT Touch Panel and Mimic Diagram (NEW!)

6.4 ANALOG GAUGES (Option-04)

In this option, standart (72x72mm or 96x96mm) 1.5 % accurate gauges are provided for easy observation of some operation measurements. These gauges or mounted on the front door of the enclosure.

Depending on request, following values can be measured and observed :

- AC Input voltage(s) (with selective switch in 3 phase input devices)
- AC Input current(s) (with selective switch in 3 phase input devices)
- Rectifier DC Output / Load Voltage
- Rectifier DC Output / Load Current
- Battery Voltage
- Battery Current (charge and discharge, bidirectional)



Figure 6.4 Gauges (example application)

NOTE

On equipments where gauges option is applied, LCD panel and keypad is not removed and remain functional.

6.5 LOAD VOLTAGE LIMITATION MODULE / VOLTAGE DROP (Option-05)

This option provides separate load and battery outputs with different voltage levels.

In this option, the voltage applied to batteries on equalizing charge or boost charge is limited by diode groups as needed and applied to load output. This way, a high voltage to the load is prevented.

6.6 BATTERY CHARGE TEMPERATURE COMPENSATION (Option-06)

This option provides the compensation of charge voltage depending on the ambient temperature of the battery room. This kind of charge lengthens the battery life. A temperature sensor connected to the rectifier is placed to the environment where batteries are installed.

Typical temperature compensation graph for a 12V battery (6 cells) is given below.

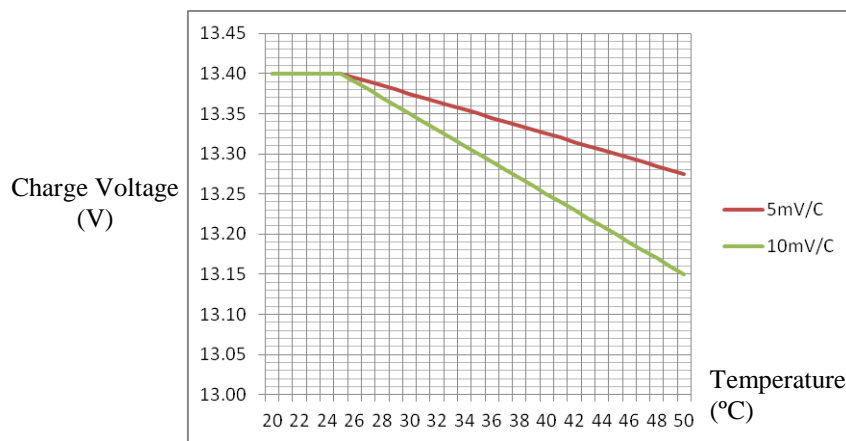

Figure 6.5 Battery Temperature Compensation

6.7 INTERNAL CABINET LIGHTING (Option-07)

In this option, a LED lighting module is mounted inside the top of the rectifier cabinet to allow the user perform service easier. The lighting module is energized by the activation of a door switch. The lighting module uses LED technology and has a long life time. The lighting modules power supply is protected by a fuse.

6.8 INTERNAL CABINET HEATER (Option-08)

In this option, an anticondensing heater with thermostat control is provided to condensation especially in cold and harsh environments. The heaters increase the cabinet internal temperature in case the temperature drops below a adjustable level. This option is especially preferred in cold and output applications.

6.9 INPUT POWER MEASUREMENT (Option-09)

This option adds input current transformers and provides the following measurement on the LCD panel :

- AC Input current(s)
- AC Input apparent power(s)
- AC Input power factor(s)

6.11 TRANSDUCERS (Option-11)

Opt 11 provides up the 8 channels transducers. Each channel can be programmed to any source (Input / Output / Battery Voltage / Current) inside the **Main Menu > Functional > Expansion Port**. Each channel provides 0 10V and 4 20mA at the same time. Transducer outputs are isolated from the rest of the system.

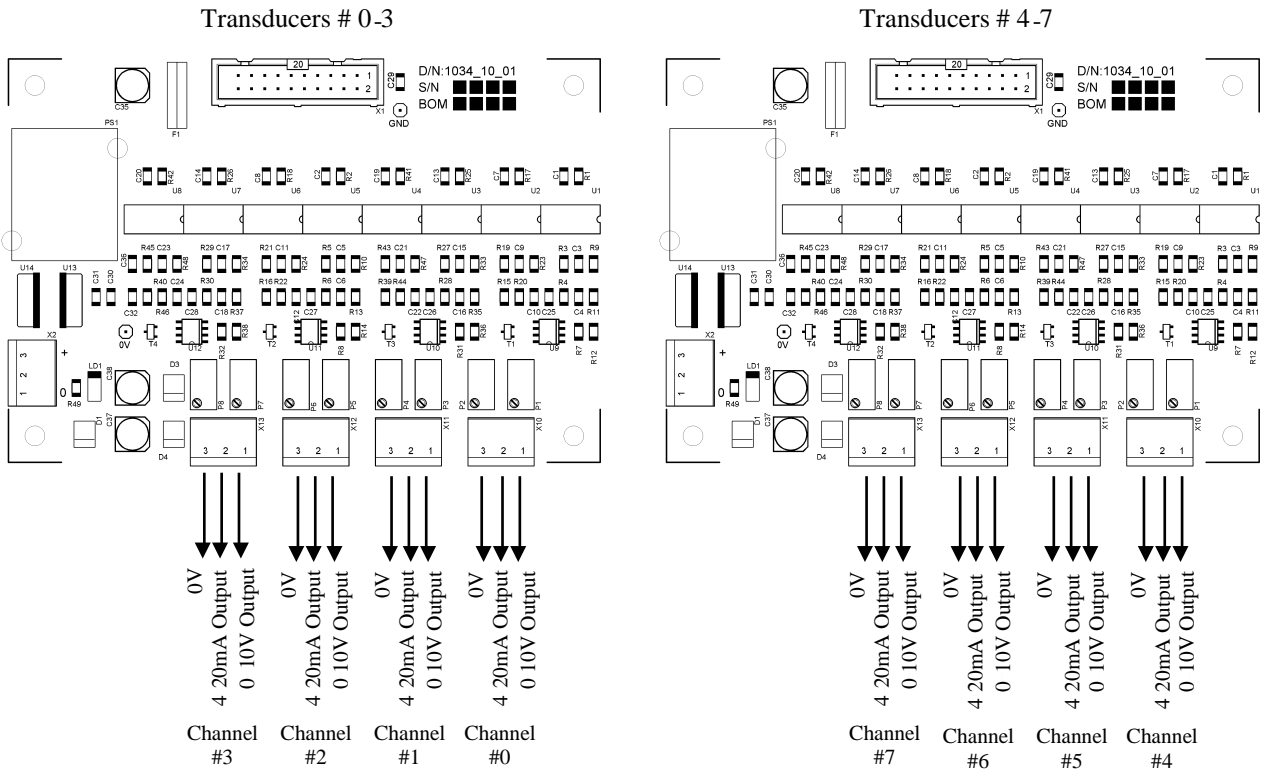

Figure 6.7 Transducer outputs

6.13 ACTIVE PARALLEL CURRENT SHARING (Option-13)

Thanks to the output blocking diode, AETES Rectifier can be connected in parallel, without any additional hardware. In such a configuration, output current of each device is defined by its voltage. A higher voltage device will supply higher current than the other devices. This continues until one device reaches current limit and after that, other devices will slowly reach the first device's current value. Finally, the current sharing is performed by physical laws. In active parallel current sharing, rectifiers communicate by the CAN bus. Therefore, they present a more common behaviour and share the output current more precisely. Up to 4 devices can be connected in parallel to increase output power and redundancy. Rectifier communication is established by CANBUS.

6.14 FAST ACTING SEMICONDUCTOR FUSES (Option-14)

Fast acting semiconductor fuses provided with this option are protecting thyristor power switches and so increasing safety. In any instant overload condition, semiconductor fuses act faster than the thyristor and protect the thyristor from any permanent damage.

6.15 FAN FAILURE MONITORING (Option-15)

In this option, a fan current detected is added to each of the cooling fans. In case of any cooling fan failure, a FAN FAILURE message is displayed on LCD and led indicator.

MODBUS ADDRESS TABLE

NOTE

Modbus addresses provided in the list are valid according to the most update software version (V3.26) on the date this users manual is prepared. Some new addresses may be added in newer versions, but backward compability is maintained.
Contact your dealer if needed.

AETES Rectifier Modbus Adress Table V3.26					
Address	Type	Register / Coil	Scale	Validity	Description
0x0000	Coil				
0x0001	Coil				
0x0002	Coil				
0x0003	Coil				
0x0004	Coil				
0x0005	Coil				
0x0006	Coil				
0x0007	Coil				
0x0008	Coil				
0x0009	Coil				
0x000A	Coil				
0x000B	Coil				
0x000C	Coil				
0x000D	Coil				
0x000E	Coil				
0x000F	Coil				
0x0010	Coil	StartRequest		3.00	1 : START REQUEST
0x0011	Coil	StopRequest		3.00	1 : STOP REQUEST
0x0012	Coil	AlarmResetRequest		3.00	1 : ALARM RESET REQUEST
0x0013	Coil	AppParamSaveRequest		3.00	1 : SAVE REQUEST
0x0014	Coil	SystemParamSaveRequest		3.05	1 : SAVE REQUEST
0x0015	Coil				
0x0016	Coil				
0x0017	Coil				
0x0018	Coil				
0x0019	Coil				
0x001A	Coil				
0x001B	Coil				
0x001C	Coil				
0x001D	Coil				
0x001E	Coil				
0x001F	Coil				
0x0020	Register	OutputVoltage	x 0.1V	3.00	
0x0021	Register	OutputCurrent	x 0.1A	3.00	

0x0022	Register	Line Voltage RMS L1	V	3.00	
0x0023	Register	Line Voltage RMS L2	V	3.00	
0x0024	Register	Line Voltage RMS L3	V	3.00	
0x0025	Register	Battery Voltage	x 0.1V	3.00	
0x0026	Register	Battery Current	x 0.1A	3.00	
0x0027	Register	Battery Temperature	C	3.00	
0x0028	Register	Line Frequency	x 0.1Hz	3.06	
0x0029	Register				
0x002A	Register	Line Voltage RMS L12	V	3.00	
0x002B	Register	Line Voltage RMS L23	V	3.00	
0x002C	Register	Line Voltage RMS L31	V	3.00	
0x002D	Register	Line Current RMS L1	V	3.00	
0x002E	Register	Line Current RMS L2	V	3.00	
0x002F	Register	Line Current RMS L3	V	3.00	
0x0030	Register	ApplicationMode		3.00	0 : STOP 1 : RUN
0x0031	Register	ApplicationFaultStatusLow		3.00	BIT 0 : LINE FAILURE
				3.00	BIT 1 : DC LOW
				3.00	BIT2 : DC HIGH
				3.00	BIT 3 : CURRENT LIMIT
				3.00	BIT 4 : BATTERY TOO LOW
				3.00	BIT 5 : BATTERY LOW
				3.00	BIT 6 : BATTERY HIGH
				3.00	BIT 7 : OVER TEMP
				3.00	BIT 8 : EARTH FAULT
				3.00	BIT 9 : MEMORY ERROR
				3.00	BIT 10 : FAN FAILURE
				3.00	BIT 11 : BREAKER OPEN
				3.00	BIT 12 : FUSE FAILURE
				3.00	BIT 13 : DOOR OPEN
				3.00	BIT 14 : HARDWARE BLOCK
3.00	BIT 15 : TEMPERATURE PROBE FAILURE				
0x0032	Register	ChargeMode		3.00	0 : AUTOMATIC
				3.00	1 : FLOAT
				3.00	2 : EQUALIZE
				3.00	3 : BOOST
				3.25	4 : TEST
0x0033	Register	Vnom Output	V	3.00	
0x0034	Register	Inom Output	A	3.00	
0x0035	Register	Vnom Input	V	3.00	BIT0...BIT14 : Nominal Voltage BIT15=0 : SINGLE PHASE, BIT15=1 : THREE PHASE
0x0036	Register	DSP Version		3.00	
0x0037	Register	PIC Version		3.00	
0x0038	Register	Alarm Relay Status K1		3.00	0 : ALARM (DEENERGISED) 1 : NO ALARM (ENERGISED)
0x0039	Register	Alarm Relay Status K2		3.00	
0x003A	Register	Alarm Relay Status K3		3.00	
0x003B	Register	Alarm Relay Status K4		3.00	
0x003C	Register	ApplicationFaultStatusHigh		3.01	BIT 0 : FLOAT CHARGE
				3.01	BIT 1 : EQUALIZE CHARGE
				3.01	BIT 2 : BOOST CHARGE
				3.01	BIT 3 : BOOST EXPIRED
				3.01	BIT 4 : EMERGENCY STOP
				3.01	BIT 5 : PARALLEL FAULT
				3.01	BIT 6 : TEMPERATURE PRE ALARM
3.01	BIT 7 : 12PULSE FAILURE				

				3.06	BIT 8 : BATTERY TEST FAILED
				3.08	BIT 9 : BAD PHASE SEQUENCE (12 Pulse Devices)
				3.20	BIT 10 : BOOST INHIBIT
				3.22	BIT 11 : PROBE TEMPERATURE HIGH
0x003D	Register	Phase Rotation		3.05	0 : CLOCKWISE, 1 : COUNTERCLOCKWISE
0x003E	Register				
0x003F	Register				
0x0040	Register	ControlSource		3.00	0 : KEYPAD
				3.00	1 : COMM.
				3.00	2 : TERMINAL
0x0041	Register	StartMode		3.00	0 : MANUAL
				3.00	1 : AUTOMATIC
0x0042	Register	Language		3.00	0 : ENGLISH
				3.00	1 : GERMAN
				3.00	2 : TURKISH
				3.00	3 : NETHERLAND
				3.00	4 : PORTUGESE
0x0043	Register	Serial Link		3.00	0 : NONE
				3.00	1 : FREEMASTER
				3.00	2 : MODBUS
0x0044	Register	Charge Mode Set		3.00	0 : AUTOMATIC
				3.00	1 : FLOAT
				3.00	2 : EQUALIZE
				3.00	3 : BOOST
0x0045	Register	Float Voltage	x 0.1V	3.00	
0x0046	Register	Equalize Voltage	x 0.1V	3.00	
0x0047	Register	Boost Voltage	x 0.1V	3.00	
0x0048	Register	DC Low	x 0.1V	3.00	
0x0049	Register	DC High	x 0.1V	3.00	
0x004A	Register	Battery Too Low	x 0.1V	3.00	
0x004B	Register	Battery Low	x 0.1V	3.00	
0x004C	Register	Battery High	x 0.1V	3.00	
0x004D	Register	Current Limit	x 0.1A	3.00	
0x004E	Register	Boost Duration	min	3.00	
0x004F	Register	Temp. Compansation	C	3.00	
0x0050	Register	Battery Current Limit	x 0.1A	3.00	
0x0051	Register	RampForcedV	sec	3.02	
0x0052	Register	RampForcedI	sec	3.02	
0x0053	Register	DC Hysterisis	x 0.1V	3.06	
0x0054	Register	Test Voltge	X 0.1V	3.10	
0x0055	Register	Test Duration	minutes	3.10	
0x0056	Register	Float Current	X 0.1A	3.20	
0x0057	Register	Equalize Current	X 0.1A	3.20	
0x0058	Register				
0x0059	Register				
0x005A	Register				
0x005B	Register				
0x005C	Register	External Input Status		3.20	Bit n :> 0 : FALSE, 1 : TRUE
0x005D	Register				
0x005E	Register				
0x005F	Register				
0x0060	Register	Power Active L1	x 0.1kW	3.00	
0x0061	Register	Power Active L2	x 0.1kW	3.00	
0x0062	Register	Power Active L3	x 0.1kW	3.00	
0x0063	Register	Power Reactive L1	x 0.1kVAr	3.00	
0x0064	Register	Power Reactive L2	x 0.1kVAr	3.00	
0x0065	Register	Power Reactive L3	x 0.1kVAr	3.00	



**RECTIFIER CHARGER 1PH 20A-100A
INSTRUCTION MANUAL**

0x0066	Register	Power Apparent L1	x 0.1kVA	3.00	
0x0067	Register	Power Apparent L2	x 0.1kVA	3.00	
0x0068	Register	Power Apparent L3	x 0.1kVA	3.00	
0x0069	Register	Power Factor L1		3.00	
0x006A	Register	Power Factor L2		3.00	
0x006B	Register	Power Factor L3		3.00	
0x006C	Register				
0x006D	Register				
0x006E	Register				
0x006F	Register				
0x0070	Register	RelayForceEnabled		3.07	
0x0071	Register	RelayForceValue		3.07	
0x0072	Register				
0x0073	Register				
0x0074	Register				
0x0075	Register				
0x0076	Register				
0x0077	Register				
0x0078	Register				
0x0079	Register				
0x007A	Register				
0x007B	Register				
0x007C	Register				
0x007D	Register				
0x007E	Register				
0x007F	Register				
0x0080	Register				
0x0081	Register				
0x0082	Register				
0x0083	Register				
0x0084	Register				
0x0085	Register				
0x0086	Register				
0x0087	Register				
0x0088	Register				
0x0089	Register				
0x008A	Register				
0x008B	Register				
0x008C	Register				
0x008D	Register				
0x008E	Register				
0x008F	Register				
0x0090	Register	Calibrator - Output Voltage		3.05	Output Voltage
0x0091	Register	Calibrator - Output Current		3.05	Output Current
0x0092	Register	Calibrator - Battery Voltage		3.05	Battery Voltage
0x0093	Register	Calibrator Battery Current		3.05	Battery Current
0x0094	Register	Calibrator Line Voltage L1		3.05	Line Voltage L1 (RMS)
0x0095	Register	Calibrator Line Voltage L2		3.05	Line Voltage L2 (RMS)
0x0096	Register	Calibrator Line Voltage L3		3.05	Line Voltage L3 (RMS)
0x0097	Register	Calibrator Line Current L1		3.05	Line Current L1 (RMS)
0x0098	Register	Calibrator Line Current L2		3.05	Line Current L2 (RMS)
0x0099	Register	Calibrator Line Current L3		3.05	Line Current L3 (RMS)
0x009A	Register				
0x009B	Register				
0x009C	Register				
0x009D	Register				
0x009E	Register				



**RECTIFIER CHARGER 1PH 20A-100A
INSTRUCTION MANUAL**

0x009F	Register				
0x00A0	Register				
0x00A1	Register				
0x00A2	Register				
0x00A3	Register				
0x00A4	Register				
0x00A5	Register				
0x00A6	Register				
0x00A7	Register				
0x00A8	Register				
0x00A9	Register				
0x00AA	Register				
0x00AB	Register				
0x00AC	Register				
0x00AD	Register				
0x00AE	Register				
0x00AF	Register				